

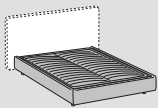

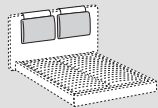









 Testiera - Headboard	 Giroletto - Bed frame	 Cuscini - Cushions	
<b>Rivestimento Upholstering (8)</b> Sfoderabile Removable		 	 	
Non sfoderabile Not removable	 	-	-	
<b>Imbottiture Padding (3-4-5-6-7)</b>	 +  D.30kg/m <sup>3</sup>	 +  D.30/40kg/m <sup>3</sup>		

## INFORMAZIONI TECNICHE

### Struttura: 1-2

Testiera in pannelli di legno multistrato abbinati a pannelli di particelle di legno in classe E1 e faesite, longoni e pediera in pannelli di legno multistrato in classe E1.

### Note:

Per finitura bicolore ovvero pannello della testiera in tessuto o similpelle, cuscino testiera in tessuto e giroletto in tessuto o similpelle, considerare il prezzo della categoria più alta dei rivestimenti utilizzati. Giroletto sempre completo di coprirete.

Piedi a ponte in legno di faggio in versione "cover" o "gipsy" parzialmente ricoperti con rivestimento non sfoderabile.

Caratteristiche relative ai materiali utilizzati descritte nella sezione tecnica a fine listino.

Set biancheria da letto e coprirete disponibili nella sezione accessori per letti.

## TECHNICAL INFORMATION

### Structure: 1-2

Headboard in plywood panels combined with class E1 and Faesite particleboard panels; frame members and footboard in class E1 plywood panels.

### Notes:

For two-colour finish, with headboard panel in fabric or artificial leather, headboard cushion and bed-frame in fabric or artificial leather, please consider the price of the most expensive category of covers used. Bed frame always includes the slats cover.

"cover" or "gipsy" beech wooden foot bar partially covered with not removable coating.

For characteristics related to the materials used, see the technical section at the end of the pricelist.

Bed linen and bed-base cover set available in the section "Bed accessories"

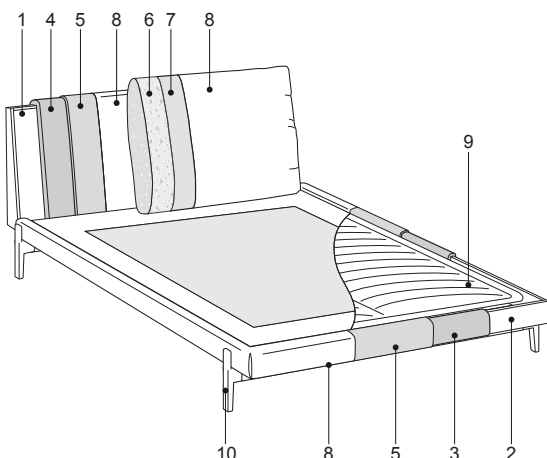

Versioni disponibili (per dimensioni selezionate)

Available versions (by selected dimensions)

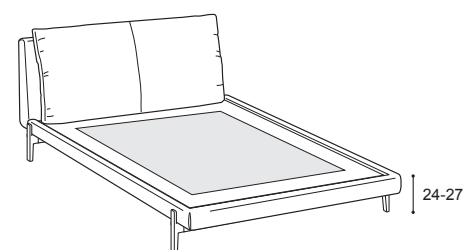







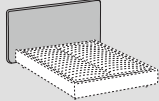
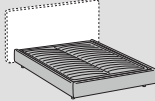
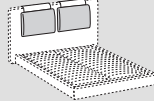

Disponibile per materasso da:  
Available for mattress:



# Kim mix

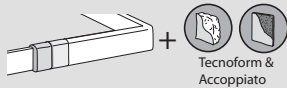

	 Testiera - Headboard	 Giroletto - Bed frame	 Cuscini - Cushions	
<b>Rivestimento Upholstering (8)</b> Sfoderabile <i>Removable</i>	-	-		
Non sfoderabile <i>Not removable</i>			-	
<b>Imbottiture Padding (3-4-5-6-7)</b>	 +  D.30kg/m <sup>3</sup>	 D.30/40kg/m <sup>3</sup>		

## INFORMAZIONI TECNICHE

### Struttura: 1-2

Testiera in pannelli di legno multistrato abbinati a pannelli di particelle di legno in classe E1 e faesite, longoni e pediera in pannelli di legno multistrato in classe E1.

### Note:

Pannello della testiera e giroletto rivestiti in pelle Cat. Soft, cuscino della testiera disponibile in tessuto. Per letto con parti in pelle di altre categorie aggiungere la maggiorazione indicata. Giroletto sempre completo di coprire. Piedi a ponte in legno di faggio in versione "cover" o "gipsy" parzialmente ricoperti con rivestimento non sfoderabile. Caratteristiche relative ai materiali utilizzati descritte nella sezione tecnica a fine listino.

Set biancheria da letto e coprire disponibili nella sezione accessori per letti.

## TECHNICAL INFORMATION

### Structure: 1-2

Headboard in plywood panels combined with class E1 and Faesite particleboard panels; frame members and footboard in class E1 plywood panels.

### Notes:

Headboard panel and bed frame upholstered in Soft Cat. leather, headboard cushion available in fabric. For bed with leather parts of different categories, please add the indicated surcharge. Bed frame always includes the slats cover.

"cover" or "gipsy" beech wooden foot bar partially covered with not removable coating.

For characteristics related to the materials used, see the technical section at the end of the pricelist.

Bed linen and bed-base cover set available in the section "Bed accessories"

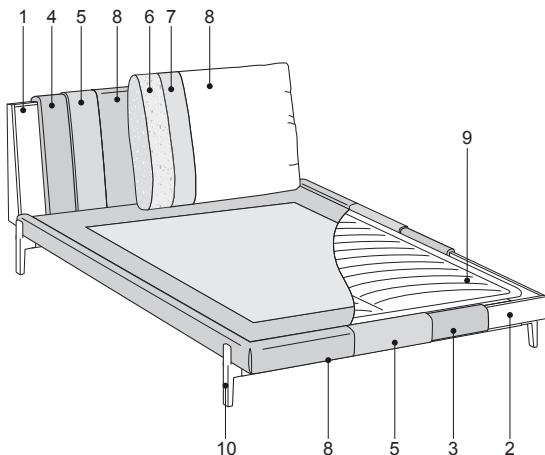

Versioni disponibili (per dimensioni selezionate)

Available versions (by selected dimensions)

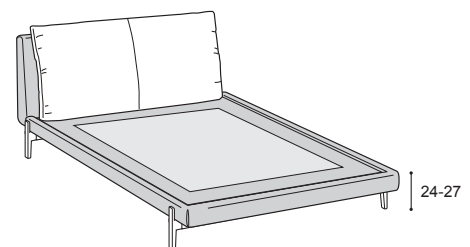

Disponibile per materasso da:  
 Available for mattress:

