

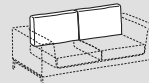

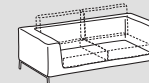









 Seduta - Seat	 Schienali - Backrests	 Struttura - Structure	
<b>Rivestimento Upholstering (10)</b>	Sfoderabile Removable   	  	 	
Non sfoderabile Not removable	—	—	 	
<b>Imbottiture Padding (3-4-6-7-8-9)</b>	 D.35kg/m³	 D.18kg/m³	 Pol.espanso	 Optional

## INFORMAZIONI TECNICHE

### Struttura: 1-2

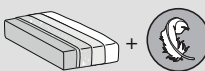
Struttura base in pannelli di legno multistrati in classe E1, Elementi strutturali in pannelli di particelle di legno in classe E1 e tamponamenti in faesite.

### Molleggio: 1-5

Schienale in pannello di particelle di legno.

Seduta in nastri elastici di fibra propilenica e lattice incrociati e meccanicamente pretensionati.

### Note:

Il piedino DUAL sporge di 3cm dal bracciolo, le dimensioni degli elementi di conseguenza variano.

## TECHNICAL INFORMATION

### Structure: 1-2

Frame structure in plywood panels in class E1, Structural elements in wood particle panels in class E1 and infill in faesite.

### Springing: 1-5

Back panel made of wood particles.

Seat with pre-tensioned crossed propylene fibre and latex elastic webbing.

### Note:

The DUAL foot protrudes by 3 cm with respect to the armrest, the size of the products varies as a result.

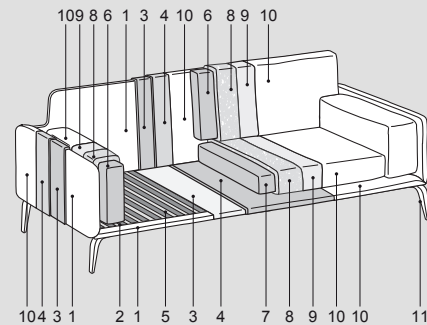
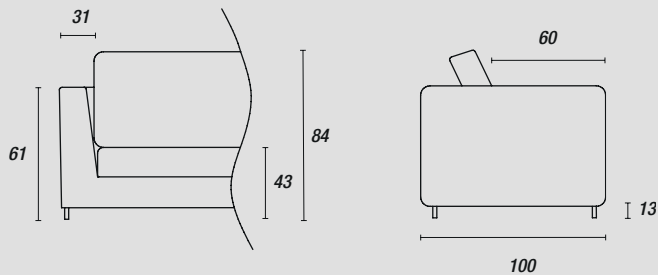

### Piedini - Feet:

#### di serie Bjorg



Nero (ME09)  
Light brown (ME11)  
Antracite (ME01)  
Testa di moro (ME03)

#### optional Bjorg



con maggiorazione  
Cromo nero (ME05)  
Peltro (ME13)

#### optional Dual

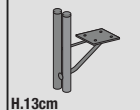

con maggiorazione  
Nero (ME09)

#### optional Up

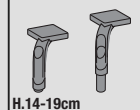

con maggiorazione  
Nero (ME09)  
Light brown (ME11)





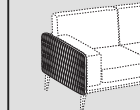



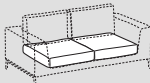
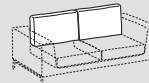
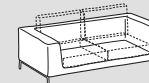

### Accessori - Accessories:

#### Bracciolo trapuntato

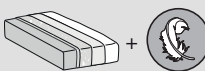

# Kris Mix



	 Seduta - Seat	 Schienali - Backrests	 Struttura - Structure	
<b>Rivestimento Upholstering (10)</b> Sfoderabile Removable	 	 	-	
Non sfoderabile Not removable	-	-		
<b>Imbottiture Padding (3-4-6-7-8-9)</b>	 D.35kg/m³	 D.18kg/m³	 Pol.espanso	 Optional

## INFORMAZIONI TECNICHE

### Struttura: 1-2

Struttura base in pannelli di legno multistrati in classe E1, Elementi strutturali in pannelli di particelle di legno in classe E1 e tamponamenti in faesite.

### Molleggio: 1-5

Schienale in pannello di particelle di legno.

Seduta in nastri elastici di fibra propilenica e lattice incrociati e meccanicamente pretensionati.

### Note:

Scocca rivestita in pelle Cat. Soft; per articolo imbottito con parti in pelle di altre categorie, aggiungere la maggiorazione indicata.

**Il piedino DUAL sporge di 3cm dal bracciolo, le dimensioni degli elementi di conseguenza variano.**

## TECHNICAL INFORMATION

### Structure: 1-2

Frame structure in plywood panels in class E1, Structural elements in wood particle panels in class E1 and infill in faesite.

### Springing: 1-5

Back panel made of wood particles.

Seat with pre-tensioned crossed propylene fibre and latex elastic webbing.

### Note:

Base covered with Soft leather; for articles upholstered with leather parts from other categories, consider the indicated surcharge

**The DUAL foot protrudes by 3 cm with respect to the armrest, the size of the products varies as a result.**

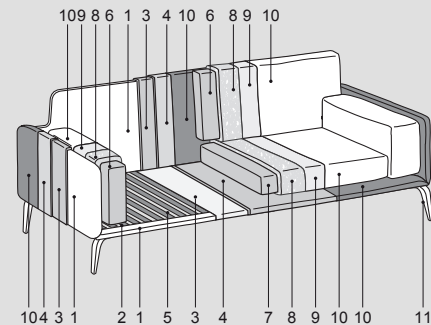
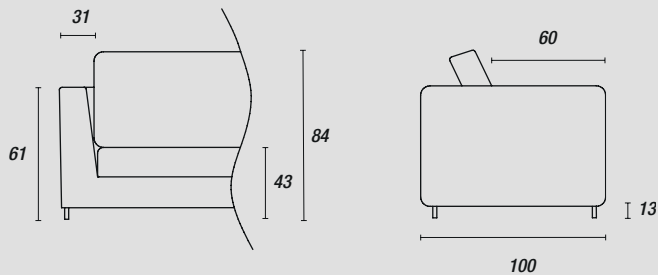

### Piedini - Feet:

#### di serie Bjorg



Nero (ME09)  
Light brown (ME11)  
Antracite (ME01)  
Testa di moro (ME03)

#### optional Bjorg



con maggiorazione  
Cromo nero (ME05)  
Peltro (ME13)

#### optional Dual

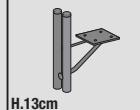

con maggiorazione  
Nero (ME09)

#### optional Up

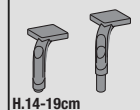

con maggiorazione  
Nero (ME09)  
Light brown (ME11)

### Accessori - Accessories:

#### Bracciolo trapuntato

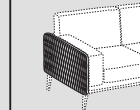

# Kris Low



	Seduta - Seat	Schienali - Backrests	Struttura - Structure	
<b>Rivestimento Upholstering (10)</b>	Sfoderabile Removable Non sfoderabile Not removable	Sfoderabile Removable Non sfoderabile Not removable	Sfoderabile Removable Non sfoderabile Not removable	
<b>Imbottiture Padding (3-4-6-7-8-9)</b>	D.35kg/m³	D.18kg/m³	Pol.espanso	<b>ECOSY</b> ETHICALLY SOFT MADE Optional

## INFORMAZIONI TECNICHE

### Struttura: 1-2

Struttura base in pannelli di legno multistrati in classe E1, Elementi strutturali in pannelli di particelle di legno in classe E1 e tamponamenti in faesite.

### Molleggio: 1-5

Schienale in pannello di particelle di legno. Seduta in nastri elastici di fibra propilenica e lattice incrociati e meccanicamente pretensionati.

### Note:

Il piedino DUAL sorge di 3cm dal bracciolo, le dimensioni degli elementi di conseguenza variano.

## TECHNICAL INFORMATION

### Structure: 1-2

Frame structure in plywood panels in class E1, Structural elements in wood particle panels in class E1 and infill in faesite.

### Springing: 1-5

Back panel made of wood particles. Seat with pre-tensioned crossed propylene fibre and latex elastic webbing.

### Note:

The DUAL foot protrudes by 3 cm with respect to the armrest, the size of the products varies as a result.

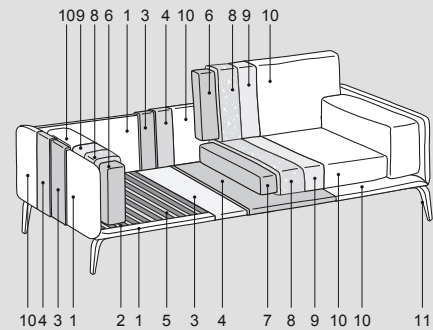
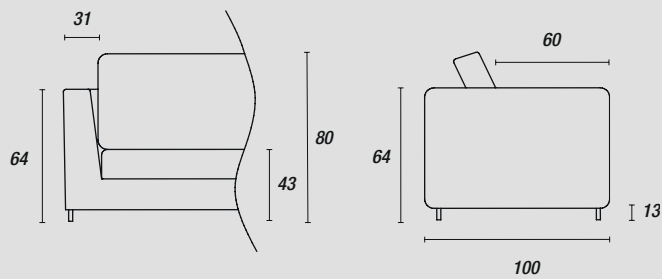

### Piedini - Feet:

#### di serie Bjorg



Nero (ME09)  
Light brown (ME11)  
Antracite (ME01)  
Testa di moro (ME03)

#### optional Bjorg



con maggiorazione  
Cromo nero (ME05)  
Pietro (ME13)

#### optional Dual

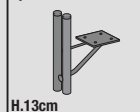

con maggiorazione  
Nero (ME09)

#### optional Up



con maggiorazione  
Nero (ME09)  
Light brown (ME11)

### Accessori - Accessories:

#### Bracciolo trapuntato

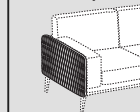

# Kris Mix Low



	Seduta - Seat	Schienali - Backrests	Struttura - Structure	
<b>Rivestimento Upholstering (10)</b>	Sfoderabile / Removable Non sfoderabile / Not removable	Sfoderabile / Removable Non sfoderabile / Not removable	-	-
<b>Imbottiture Padding (3-4-6-7-8-9)</b>	D.35kg/m³	D.18kg/m³	Pol.espanso	<b>ECOSY</b> ETHICALLY SOFT MADE Optional

## INFORMAZIONI TECNICHE

### Struttura: 1-2

Struttura base in pannelli di legno multistrati in classe E1, Elementi strutturali in pannelli di particelle di legno in classe E1 e tamponamenti in faesite.

### Molleggio: 1-5

Schienale in pannello di particelle di legno.  
Seduta in nastri elastici di fibra propilenica e lattice incrociati e meccanicamente pretensionati.

### Note:

Scocca rivestita in pelle Cat. Soft; per articolo imbottito con parti in pelle di altre categorie, aggiungere la maggiorazione indicata. Bordo di serie tono su tono, se in contrasto specificare il colore.

Il piedino DUAL sporge di 3cm dal bracciolo, le dimensioni degli elementi di conseguenza variano.

## TECHNICAL INFORMATION

### Structure: 1-2

Frame structure in plywood panels in class E1, Structural elements in wood particle panels in class E1 and infill in faesite.

### Springing: 1-5

Back panel made of wood particles.  
Seat with pre-tensioned crossed propylene fibre and latex elastic webbing.

### Note:

Base covered with Soft leather; for articles upholstered with leather parts from other categories, consider the indicated surcharge. Tone on tone edge as a standard, if contrasting, specify the color.

The DUAL foot protrudes by 3 cm with respect to the armrest, the size of the products varies as a result.

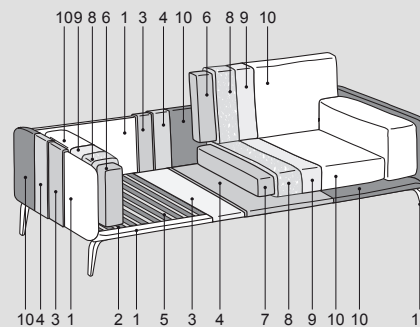
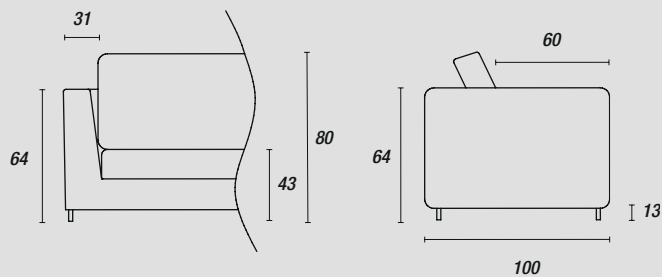

### Piedini - Feet:

#### di serie Bjorg



Nero (ME09)  
Light brown (ME11)  
Antracite (ME01)  
Testa di moro (ME03)

#### optional Bjorg



con maggiorazione  
Cromo nero (ME05)  
Peltro (ME13)

#### optional Dual

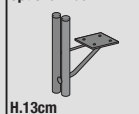

con maggiorazione  
Nero (ME09)

#### optional Up

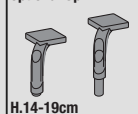

con maggiorazione  
Nero (ME09)  
Light brown (ME11)

### Accessori - Accessories:

#### Bracciolo trapuntato

