

divano/sofa Gary

elementi/elements

designed by Castello Lagravinese



Struttura portante: Multistrato, massello di legno.

Imbottiture: Cuscino di schienale in piuma d'oca con particelle in fibra di poliestere e poliuretano espanso; cuscino di seduta in poliuretano espanso a densità differenziata. Scocca in poliuretano espanso a densità differenziata, rivestito in resinato 100 gr.

Molleggio: Cinghie elastiche in polipropilene e gomma.

Piedini: in abs.

Main structure: Solid and multilayer wood.

Upholstery: Back cushion in goose feathers with chips of polyester fiber and polyurethane foam; seat cushion in polyurethane foam with different densities. Chassis in polyurethane foam with different densities, covered with resinated 100 grams.

Suspensions: Elastic belts in polypropylen and rubber.

Feet: in abs.

Cod. Tessuto/fabric: 1/01

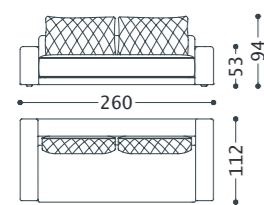
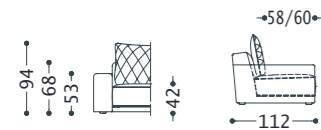

1GARD3M

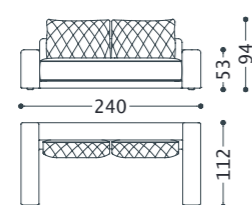

1GARD3

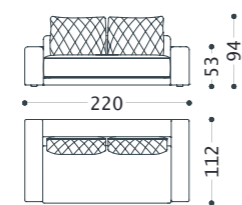

1GARD2M

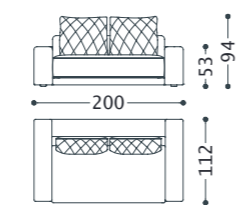

1GARD2

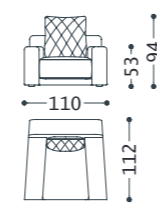

1GARP

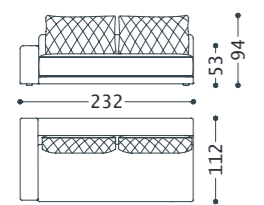

1GARD3MSX

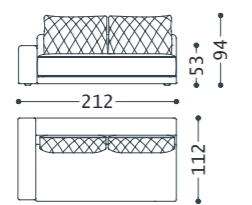

1GARD3SX

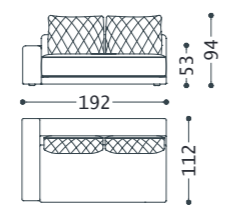

1GARD2MSX

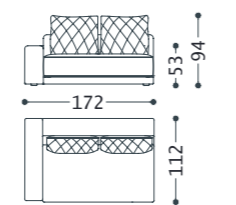

1GARD2SX

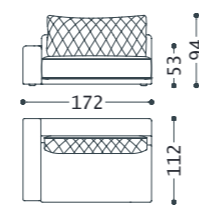

1GARD2SPSX

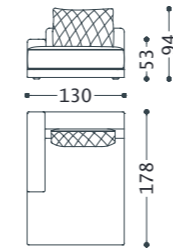

1GARDORMXSX

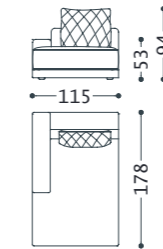

1GARDORMSX

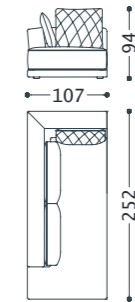

1GARMERSX

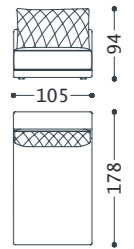

1GARCHL

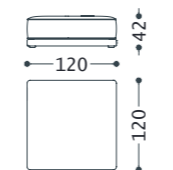

1GARRPQG

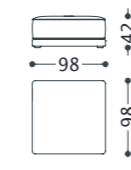

1GARQPQ

divano/sofa Gary

composizioni/compositions

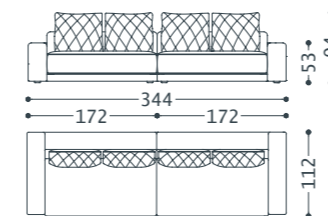

01GARC1
(1GARD2SX-1GARD2DX)

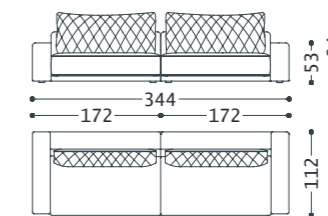

01GARC3
(1GARD2SPSX-1GARD2SPDX)

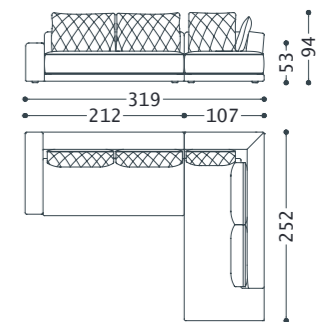

01GARC2
(1GARD3SX-1GARMERDX)